

VDC-DP7585P

Specifications

Model No.	VDC-DP7585P
Scanning system	PAL standard 625 lines, 50 fields/sec.
Image sensor	1/4" Interline transfer method CCD (3.6 x 2.7 mm)
Number of pixels	Total: 759 (H) x 596 (V), Effective: 752 (H) x 582 (V)
Horizontal resolution	More than 520 TV lines
Minimum illumination 20 IRE (approx.)	0.48 lx (F1.9, Gain High, color mode) / 0.024 lx (F1.9, Gain High, B/W mode)
50 IRE	1.2 lx (F1.9, Gain High, color mode) / 0.06 lx (F1.9, Gain High, B/W mode)
Video output	1.0 Vp-p/75 ohms, composite
Video S/N ratio	More than 50 dB (AGC Off)
Backlight compensation	ON (multi-spot metering [High/Normal], center-zone metering) / OFF
White balance	ATW / AWC / Manual (MWB) / Outdoor (3200) / Indoor (5600) / Fluorescent (FLUE)
Gain control	High / Normal / Off
Gamma	0.45 / 1
Lens	Built-in motorized zoom pan-focus auto iris lens, f=2.8-7.3 mm (x2.6), F1.9-3.0
Electronic shutter	1/50, 1/120, 1/250, 1/500, 1/1000, 1/2000, 1/4000, 1/10000 sec.
Motion detector	On / Off: Motion zoom function
Privacy masking	On / Off: Max. 4 masked locations
Alarm input	1 (NO / NC), with alarm zoom function
Character display	On / Off, Camera ID max. 16 characters, adjusting position
Synchronizing system	Internal synchronization / Line lock
Day/Night mode	Auto (High/Low) / Color / B/W: External control
Aperture compensation	High plus / High / Normal / Off
Environmental conditions	Operating Temperature: -10 to +50°C (+14 to +122°F), Humidity: within 90% RH Storage Temperature: -20 to +70°C (-4 to +158°F), Humidity: within 70% RH
Power supply	12-15V DC / 24V AC ±10%, 50 Hz
Power consumption (approx.)	3.5 W (without options), 9.5 W (with options), 23.0 W (with heater)
Dimensions (Dia. x H)	ø162 x 114.8 mm (ø6.4 x 4.5 in.)
Weight (approx.)	1.5 kg (3.3 lbs.) [without options]

Option Boards

Network board VA-50LAN	Bandwidth limit: No limit / 128 Kbps to 4 Mbps; Alarm buffer: 8 MB max., adjustable; Interface: 10BASE-T / 100BASE-TX RJ45 terminals, links shown by OSD
SSP + Twisted pair board VA-50ST	Communication protocol Coaxial control: SSP/H-SSP/PELCO-C RS485: SSP/PELCO-D Video out: Coaxial cable / Category 5 LAN cable (NVT built-in UTP video)
Heater board VA-50H	Operating environment Temperature: -30°C to +50°C [-22°F to 122°F] (24 V AC only) (with power source connected) Humidity: less than 90% RH (no condensation)

Network Function

Frame rate	Max. 25 IPS (720 x 286 pixels)
Network protocols	TCP, UDP, HTTP, HTTPS, SMTP, NTP, DHCP, FTP, UPnP™
Operating environment	
Computer	IBM PC/AT and compatible machines
OS	Windows® 2000 / Windows® XP home edition / professional
CPU	Pentium® III 800MHz or later
Memory	128MB or more
Interface	10Base-T / 100Base-TX
Display card	1,024 x 768 pixels, more than 16,000,000 colors or 24-bit color
Browser	Internet Explorer Ver. 6.0 or later

NOTE: Specifications subject to change without notice.

"IBM" and "IBM PC/AT" are trademarks of International Business Machines Corporation in the U.S.A.
"Windows" and "Internet Explorer" are registered trademarks of Microsoft Corporation in the U.S.A. and other countries.
"Pentium" is a registered trademark of Intel Corporation or its subsidiaries in the U.S.A. and other countries.

Caution: Please consult the instruction manual to ensure safe and proper operation of the product.



DI Company of SANYO Electric Co., Ltd. obtained Quality Management System ISO 9001 and Environmental Management System ISO 14001 certifications.

Distributed by:

SANYO

SANYO Electric Co., Ltd.
www.sanyosecurity.com
©2006 SANYO Printed in Japan '06.2. MA.

SMS120

Dimensions [Unit: mm (inch)]

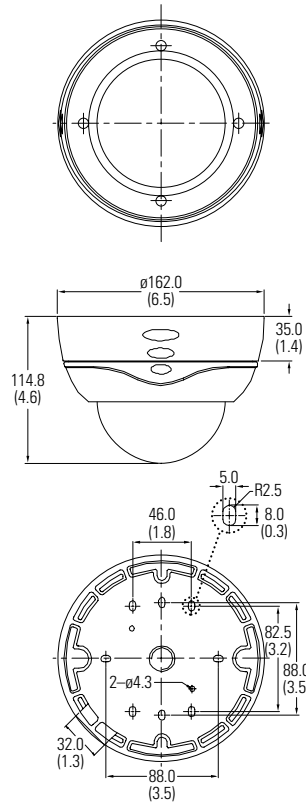

1/4" Color CCD Vandal-Resistant Dome Camera



SANYO

VDC-DP7585P

PAN-FOCUS
Technology in Perspective

DAY NIGHT

Built-in X2.6 Motorized Zoom Pan-Focus Lens

(f = 2.8 - 7.3mm) No focus adjustments



Pan-focus lens image



Varifocal lens image

520-TVL Resolution

Vandal-Resistant

IP66 Rated Enclosure

Network/UTP video
Transmission connectivity
(with board option)

Remote Camera Setting
by VAC-70

Made in Japan

The product introduced here is manufactured in Japan utilizing advanced technologies and quality control.

Comparative images are representations only.

The easy-to-install, high-performance security camera

The vandal-resistant dome camera that makes installation easy and features a pan-focus lens for a picture that's always in focus

Realizes a high-definition picture and a reduction of resources spent on installation and management with a pan-focus lens that brings all points on screen into focus while maintaining a horizontal resolution of more than 520 TV lines. Mountable on ceilings and walls and enclosed in a rugged, weatherproof housing (IP66 rating) that provides protection against the elements for outdoor use and allows it to withstand attempts by intruders to disable it. More than this, it analyzes changes in the area under surveillance and senses moving objects in the field of view via a motion detector; allows surveillance on a 24/7 basis under conditions of both day and night; and enables the development of more robust surveillance systems.



High Performance

Focuses on all objects simultaneously with x2.6 pan-focus lens

PAN-FOCUS Technology in Perspective

When using a varifocal lens, objects in front and behind the main focus point appear blurred. This has led to the development of deep-focus techniques allowing simultaneous focusing on all



Pan-focus lens image

- Clear focusing on all shooting area with great depth of field
- No focus adjustments
- Remote zoom adjustment possible with VAC-70 camera control unit and VA-50ST board option.

objects in the field of view. Early research and develop by SANYO has resulted in successful product development of a x2.6 pan-focus lens offering a picture with a greater depth of field. Now clearer pictures, even of distant objects, can be achieved with cameras for surveillance applications.



Varifocal lens image

- Clear focusing to a specific area
- Manual focus adjustments
- Manual zoom adjustments

520 TV Line Resolution

Features SANYO's DSP circuitry and a high performance 1/4-inch CCD for an industry-leading horizontal resolution of more than 520 TV lines. Delivers sharp, crisp images for greater precision in surveillance under a varied range of conditions.



Super high resolution at 520 TVL

Standard resolution

Intelligent Backlight Compensation

VDC-DP7585P features two selectable backlight compensation modes: multi-spot metering (applied to the whole screen) and center-zone metering (applied to the central portion only).

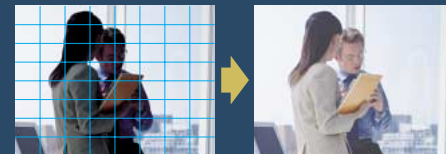

Multi-spot metering measures luminous intensity in 64 areas on screen to enable optimal backlight compensation even for peripheral and moving objects.

Flexible Motion Detection

Sensing is performed by splitting the field of view into 16 areas. Movement and brightness levels within the picture are analyzed to accurately detect surveillance targets. Upon detection, the camera sends an alarm status signal* and captures the object at zoom magnifications of up to x2.6. Fine adjustments of settings such as sensitivity, tracking time, zoom ratio and areas not requiring detection can also be made.

*Only when using VA-50LAN or VA-50ST board option (sold separately) with network or SSP connection.

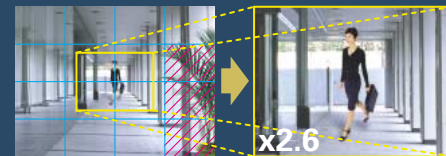

Areas with swaying trees or flickering light, etc. can be eliminated to avoid false alarms. Surveillance of the detected object can be conducted at a zoom magnification of x1.0, x1.4, x2.0 or x2.6.

Day and Night Operation

Automatic Color-B/W Switching

Providing both daytime and nighttime shooting capabilities, the camera automatically switches between color and B/W imaging modes in response to subject brightness. A HI-LOW switch enables selection of the switchover point between color and B/W modes.

Manual Switching Options

In addition to automatic switching, wiring can be performed enabling manual switching for camera operation solely in color or B/W mode irrespective of ambient lighting conditions.

Proprietary auto-switching infrared cut filter

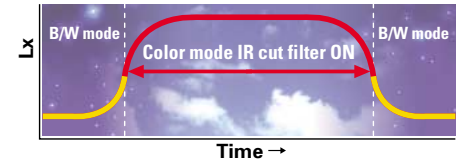

Switchover point

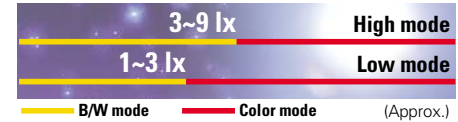

High Sensitivity, Minimum Required Illumination

B/W mode Gain: High	Color mode Gain: High	
0.024 lx	0.48 lx	(F1.9, 20 IRE)
0.06 lx	1.2 lx	(F1.9, 50 IRE)

Minimum required illumination is an impressive 0.06 lux at F1.9 in B/W mode and 1.2 lux at F1.9 in color mode.

Privacy Masking

When there is a house or even an object as small as a window within the camera frame, it is possible to mask the area so that it will not appear on the monitor screen to protect other people's privacy. Up to 4 rectangular masks of arbitrary size can be set per screen.



Rugged Construction

Tough Die-Cast Aluminum with Polycarbonate Dome

Housed in an exceptionally tough die-cast aluminum enclosure and a polycarbonate dome for extra durability under the most demanding of conditions. To protect against tampering, the fixing screws of the enclosure cover have a unique shape that prevents it from being opened with ordinary tools.

IP66 Rated Weatherproof Design

The camera's protective enclosure safely meets the IP66 standard for resistance against debilitating water and dust.

Easy Setup and Usability

Installation, setup and operation made easy by simple, user-friendly design

Based on a development concept featuring a pan-focus lens for the realization of advanced surveillance functions together with enhanced operability and ease of installation. The VDC-DP7585P increases lens function and camera maneuverability to simplify operation, save resources spent in installation and substantially heighten the available degree of freedom.

All-in-one type for easy installation

The VDC-DP7585P features an all-in-one design with built-in lens and motor. Constructed to enable removal of the camera unit without using a screwdriver, easy-to-manage wiring and installation without the need for special construction work.

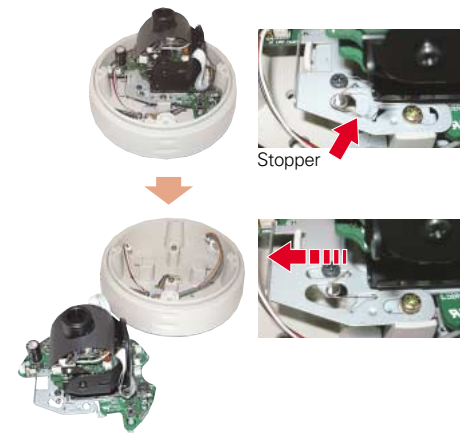

The camera unit mounted in the housing can be easily removed, allowing easy attachment and removal of optional boards.

On-screen setup and adjustment after installation

Fine-tuning of zoom ratio and video settings, etc. can be made while viewing a monitor screen when connected to the VAC-70 controller (sold separately). Saves labor during installation and allows a flexible response to changes arising after operation has been initiated.

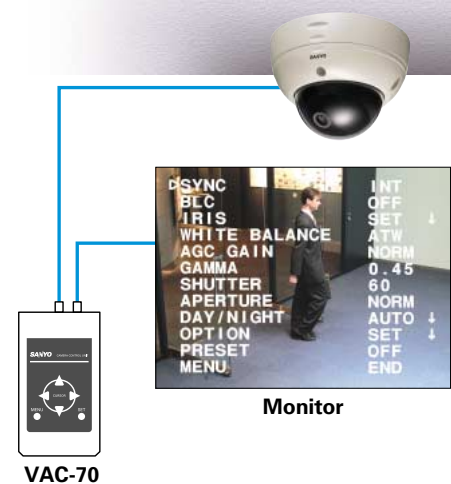

Runs on AC or DC Power Sources

The VDC-DP7585P can operate on either 12 V DC (12-15V DC) or 24 V AC (50 Hz, and even at a tolerance of ±10%). Switching to the correct mode occurs automatically when power is supplied.

Flexibility

Board options for even greater functionality

Optional boards allow adaptation to a diversity of network environments and needs.

VA-50LAN Network board	Expansion board for connection to a network configured with SANYO color CCD cameras. Enables networked operation of cameras from a computer using a web browser (Internet Explorer only). Bundled with VA-SW3050LITE (viewer software).
VA-50ST SSP + Twisted pair board	Coaxial control: SSP/H-SSP/PELCO-C RS485: SSP/PELCO-D Twisted pair terminal (CAT5) for video signal: NVT built-in UTP video
VA-50H Heater board	Heater board providing protection from cold for camera unit. Allows use in -30°C operating environments (24 V AC only).

Note: The VA-50LAN and the VA-50ST cannot be used concurrently.

Network Recorder VA-SW3050

Supplied separately as an optional software.

Compression	JPEG
Picture resolution	720 x 286 / 640 x 480 / 360 x 286 / 180 x 143 pixels
Picture quality	5 levels (Basic, Normal, Enhanced, Fine, Super Fine)
Frame rate	Max. 25 IPS (720 x 286)
Network protocols	TCP, UDP, HTTP, HTTPS, SMTP, NTP, DHCP, FTP, UPnP
Number of simultaneous log-in users	Up to 16 users (admin: only by one person)
System environment	OS: Windows® 2000 SP4 / Windows® XP/HOME/PRO SP2 CPU: Pentium® IV 2GHz or later Memory: 256MB or more Display: 1,024 x 768 pixels, 16-bit color Browser: Internet Explorer 6.0 or later

Dedicated software for recording, playback and monitoring of video feeds from a multiplicity of surveillance cameras.

