

Think GAIA

For Life and the Earth

SANYO

1/4" Color CCD High-Resolution Day/Night AF Zoom Cameras

- 30x optical zoom and 16x digital zoom
- Super-high resolution of 540 TV lines (typical)
- High sensitivity & minimum illumination of 0.016 lx at 20 IRE, 0.04 lx at 50 IRE (F1.4, B/W mode)
- Image stabilizer
- Built-in UTP video transmission connectivity (VCC-ZM600P and VCC-XZ600P)
- Simultaneous dual video streaming of H.264 and JPEG over a network (VCC-ZMN600P and VCC-XZN600P)

VCC-ZM600P PAL

VCC-XZ600P PAL

VCC-ZMN600P PAL

VCC-XZN600P PAL



VCC-XZN600P



VCC-ZMN600P

**Max. 480x Power Zoom
Captures Up-Close Details**

Super-High Resolution

540-TVL



1/4" Color CCD DSP High-Resolution
Weatherproof Day/Night AF Zoom Camera

VCC-XZ600P

VCC-XZN600P (IP Camera)

**Robust Surveillance Assured
with High Picture Quality
and High Sensitivity by Design**

Maximum 480x Zoom

The 30x optical zoom and 16x digital zoom can be combined for a close-up of 480x. This allows even distant subjects to be checked in detail, allowing one camera to monitor a wide area.

High Resolution of 540 TV Lines (typical)

SANYO has improved the horizontal resolution to 540 TV lines (typical) by developing the full capability of CCD and using an IR cut filter with enhanced performance. The result is better picture quality, which even a conventional high-resolution camera cannot match.

Adjustable Arm (VCC-XZ600P / VCC-XZN600P)

The angle of the arm is adjustable in all directions. Since the flexible joint is secured by screws, the arm maintains its position without sagging over time. In addition, a safety wire is included to prevent accidents.

Installation on a ceiling or wall is easy without any additional parts. The wires are securely protected inside the arm.

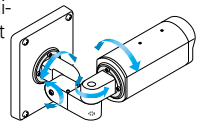

Integrated flexible arm

IP66 Compliant Enclosure

(VCC-XZ600P / VCC-XZN600P)

The protective housing meets IP66 standards for water and dust resistance.

Image Stabilizer

Image blurring due to camera vibrations that occur because of strong winds or the passing of large trucks can be electronically eliminated.



Without image stabilizer



With image stabilizer

Registering a view setting file (CAMERA VIEW)

To support shooting in various surveillance conditions like when the surveillance location is bright (or dark), the CAMERA VIEW screen allows you to register up to 2 patterns of shooting settings as camera view setting files. Of course, camera view switching in connection with external alarms or motion sensors and day/night mode setting switching is also possible.



1/4" Color CCD DSP High-Resolution
Day/Night AF Zoom Camera
VCC-ZM600P
VCC-ZMN600P (IP Camera)

DAY NIGHT

Intelligent switching from Color to B/W

Selecting Color or B/W mode can be done automatically by the camera, or else manually. In addition, the user is allowed to change the switchover point from 1 to 10 lx (nominal) using the on-screen menu. The integration of Color and high-sensitivity B/W modes in one camera makes it a versatile tool for any surveillance need. It is truly an all-in-one camera.

32X Sensitivity Boost for Minimum Illumination of 0.00125 Lx

While achieving 0.04 lx minimum subject illumination at maximum gain, sensitivity can be further heightened to 32X for 0.00125 lx minimum illumination when the sensitivity boost function is activated at 50 IRE (F1.4). [B/W mode], 0.0005 lx minimum illumination when the sensitivity boost function is activated at 20 IRE (F1.4). [B/W mode]

Built-in Intelligent Digital Motion Detector and Zoom Detector

The Intelligent Digital Motion Detector enables reliable and accurate motion detection by analyzing the "magnitude of movement" and the "size of object" from changes in picture brightness. When a moving object is detected, VCC-ZM600P / VCC-ZMN600P / VCC-XZ600P / VCC-XZN600P can send an alarm signal to external units and/or automatically switch to the optical zoom mode, according to the user's preference. Furthermore, an external alarm input terminal makes it possible, when an alarm signal is received, to automatically zoom in to the site of activity, according to a preset zooming operation.

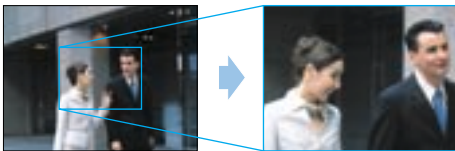

Privacy Masking

When there is a house or even an object as small as a window within the camera frame, it is possible to mask the area so that it will not appear on the monitor screen to protect other people's privacy. Up to 4 rectangular masks of arbitrary size can be set per screen. These masked areas may be protected with passwords (maximum four digits).



3 Methods of Intelligent Backlight Compensation

The VCC-ZM600P / VCC-ZMN600P and VCC-XZ600P / VCC-XZN600P feature three selectable backlight compensation modes: multi-spot metering (applied to the whole screen), center-zone metering (applied to the central portion only) and multi-spot masking.



Multi-spot metering measures luminous intensity in 48 areas on screen to enable optimal backlight compensation even for peripheral and moving objects.

13 Electronic Shutter Speed Modes

Thirteen electronic shutter speed modes (1/1.5, 1/3, 1/6, 1/12, 1/25, 1/50, 1/120, 1/250, 1/500, 1/1000, 1/2000, 1/4000 and 1/10,000 of a second) are selectable in response to brightness and movement at the monitoring point.

Operation Buttons

Use buttons provided on the side face of the camera to manually focus and zoom live images being monitored. These buttons are also used to set menu options when the menu screen is displayed.



Operations during live monitoring

- ① Set the focus
- ② Zoom out/into (Magnification: x1 to x30)
- ③ Auto focus operation

Operations on the menu screen

- ① Menu select
- ② Adjust or choose the value for the selected item
- ③ Set the value you adjusted or chose for the selected item, or switch to the sub-menu

Camera Control Unit VAC-70 (sold separately)

Connection of the VAC-70 control unit allows adjustment of zoom/focus and set-up directly from an on-screen menu.

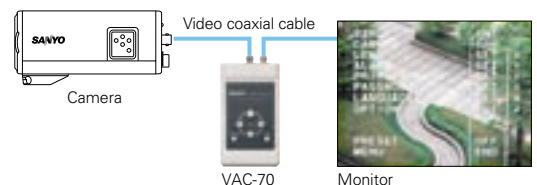

Built-in Communication Board

(VCC-ZM600P and VCC-XZ600P only)

SSP + Twisted pair board

Communication protocol:
Coaxial control: SSP / H-SSP / PELCO-C
RS485: SSP / H-SSP / PELCO-D
Twisted pair terminal (CAT 5) for video signal:
NVT built-in UTP video



Other useful features

- Adjustable gamma correction and aperture settings
- Display of assignable camera ID and titles (16 characters max.)
- Mirror function

IP Camera Solution

A Full Featured Camera with a Built-in Network Interface

A network camera is a system that allows the user to view the image captured by a camera on a network-connected PC. The advantage of using this type of camera is its low cost in system implementation. The camera is suitable for remote surveillance systems, distribution of live video, and other security systems and supports JPEG/H.264. Its ability to transmit stable video over a network makes it an ideal choice for remote surveillance.

Images monitored over a network can be checked using a general-purpose web browser (Internet Explorer)*1 or Network Monitoring Software VA-SW3050 series*2.

*1 ActiveX installation is required. *2 See page at right for details.

Transmission using 2 types of codecs (H.264 and JPEG) is possible.

For video compression, H.264, optimized for transmission of moving images over a network with low bit transfer rates, is used to enable real-time high-image-quality monitoring, and for still images JPEG is used to offer high-image-quality in a common image format. Monitoring can be performed according to the user's application, so that any important scene is not missed.

Use of a PC for Monitoring

By simply using a standard web browser, like Internet Explorer, on a personal computer, the user has access to the full color video image from the camera. In addition, a camera with a zooming function makes it possible to zoom in to a particular location of concern. The 30x optical zoom function of the 600 series makes it possible to obtain a clear picture, even in the zoom-in mode. Recording the JPEG image on a PC is also possible by the use of VA-SW3050S (for server) software.

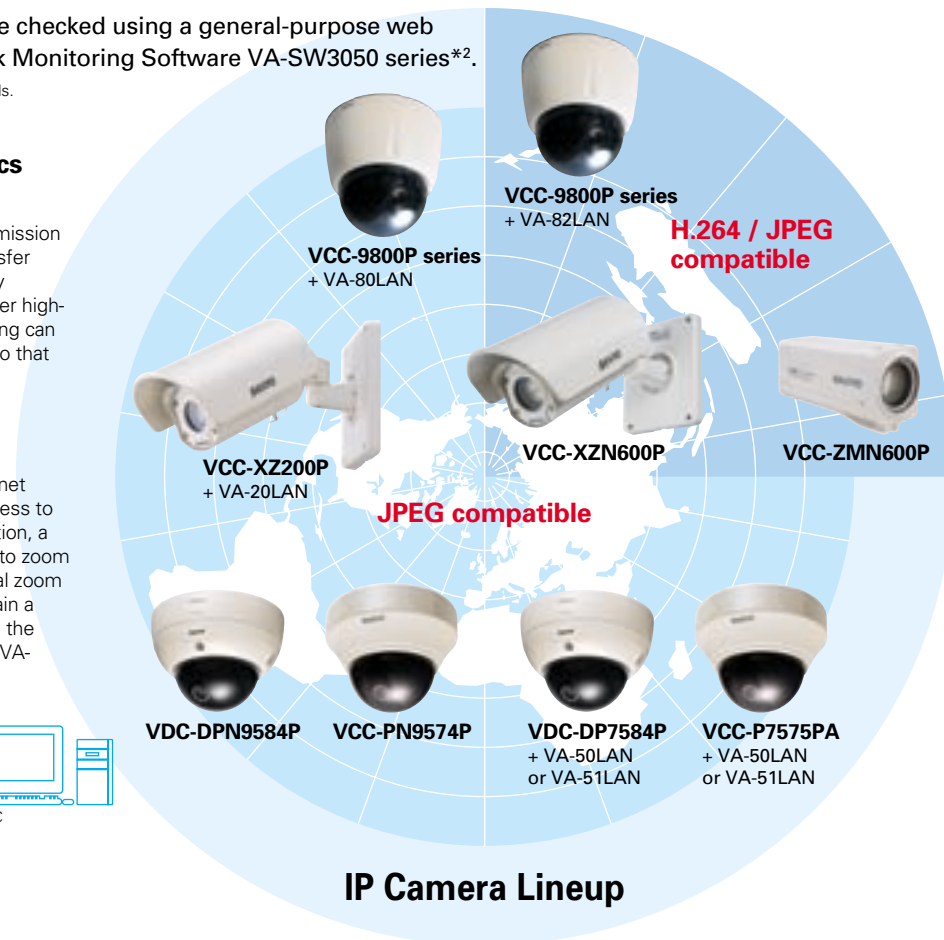
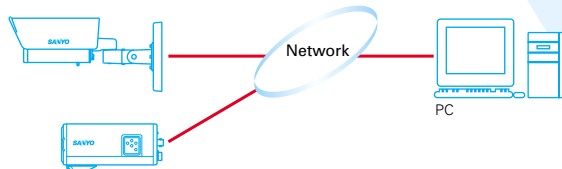

Power-over-Ethernet (PoE)

Both VCC-ZMN600P and VCC-XZN600P support the IEEE 802.3af standard for Power-over-Ethernet (PoE) applications to allow power to be supplied over LAN cabling. In addition to making installation easier, this allows camera installation in places where it would otherwise be difficult to secure a power source.

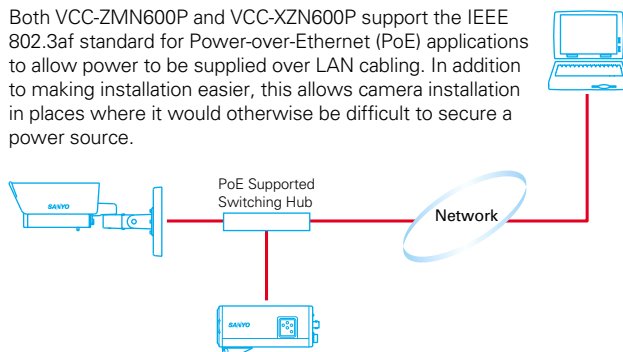

DDNS (Dynamic Domain Name System) Service compatible

The VCC-ZMN600P and VCC-XZN600P can be accessed with a fixed host name (e.g. sanyovcczmn600p), which makes the network easy to remember, always available, and secure.

E-mail function

A setting for automatic sending of mail (up to 5 addresses can be set) is provided. By using this setting, an alarm notification e-mail can be set when an alarm is detected. Or, e-mails can be sent at regular intervals. In either case, an image can be attached to the e-mail.

Schedule setting

Timer sending or alarm notification can be performed during a specified time period. The following 5 functions are provided: TIMER (SMTP) for timer sending of e-mail, TIMER (FTP) for timer sending of images via FTP mode, ALARM (SMTP) for e-mail notification of an alarm, ALARM (FTP) for sending of alarm images via FTP mode, and REMOTE ALARM "ACTIVE" for enabling camera alarm output 2 by remote operation.

Network recording software (sold separately)

VA-SW3050S (for server) / VA-SW3050C (for client)

The VCC-ZMN600P and the VCC-XZN600P are bundled with VA-SW3050LITE viewer software allowing live video streams sent from cameras to be monitored on a PC.

The network recording software VA-SW3050S / VA-SW3050C (sold separately) is an application program that extends the network operation of the camera. By installing this software, it is possible to monitor images from multiple cameras on a split screen and access and operate up to 128 cameras over a network. VA-SW3050S further offers the convenience of recording live images and alarm/timer functions. It is an exclusive software package for CCD cameras.

Live images from a single camera can be viewed on a PC using Internet Explorer*. To view live images from multiple cameras, install the included VA-SW3050LITE viewer software.

* ActiveX installation is required.
H.264 plug-in installation is required.

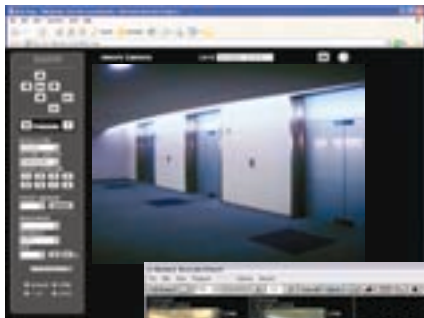

Main window (HTML)



16-screen display (VA-SW3050LITE / VA-SW3050C)



Operation panel for speed dome cameras

Operation Panel

The operation panel can be used to remotely operate a camera. Some operations can also be performed with a mouse.

Ex.) Zoom magnification can be changed by operating the mouse wheel.

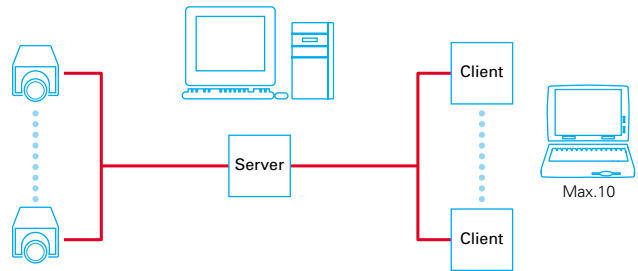

- Access to up to 128 cameras.
- Up to ten client users can be registered for each server computer, and the operational authorization level can be set differently for each camera.
- There are a variety of other optional functions to facilitate monitoring operation (VA-SW3050LITE/VA-SW3050C).
- Can split the display into one, four or sixteen screens (VA-SW3050LITE/VA-SW3050C).
- Image searching function can search through recorded images for a playback (VA-SW3050C).
- Images on the monitoring display can be printed and saved (VA-SW3050C).
- Can change camera settings, and control cameras remotely (VA-SW3050LITE/VA-SW3050C).
- Recording can be set to start automatically by timer or by alarm. (VA-SW3050S)

VA-SW3050LITE (Bundled)/VA-SW3050S/VA-SW3050C Feature Comparison

	Bundled	Sold separately	
	VA-SW3050LITE LITE	VA-SW3050S Server	VA-SW3050C Client
Number of cameras supported	Max. 128	Max. 128	Max. 128
Search camera	✓	✓	—
Live monitor	✓	—	✓
Camera Control	PTZ, etc. Menu ✓	—	✓
Video recording	—	✓	—
Playback	—	—	✓
Video search	—	—	✓
Backup	—	✓	—
Download	—	—	✓
Print	✓	—	✓

VA-SW3050LITE (Bundled)/VA-SW3050S/VA-SW3050C System Requirements

PC	IBM PC/AT and compatibles
OS	Windows® XP Professional SP2, Windows® Vista Windows® 2003 Server SP2 (VA-SW3050S only)
CPU/Memory	When the number of cameras connected is 4 or fewer: CPU: Pentium® 4, 3.0 GHz or higher, Memory: 1 GB or more When the number of cameras connected is 16 or fewer: *CPU: Pentium® 4, 3.4 GHz or higher, Memory: 2 GB or more
MEMO	When you record live videos from 17 or more cameras simultaneously on a single PC, recording operation may fail depending on your monitoring system configuration. When the recording operation fails, add PCs used for recording so that the number of cameras to record simultaneously per PC becomes 16 or fewer.
Network interface	100Base-TX
Display card	1024 x 768 pixels or higher, 16 million colors or higher AGP graphics card supporting hardware overlay Or PCI Express graphics card (Requires the latest DirectX® 9.0c compatible driver.)
Recommended graphics chip	ATI RADEON X1000 series or higher nVIDIA GeForce 6000 series or higher, Quadro4 series or higher Matrox Millenn d speakers with 100% DirectX® compatibility
Voice	Sound card and speakers with 100% DirectX® compatibility
Component	DirectX® 9.0c



Specifications

Model No.	VCC-ZM600P / VCC-ZMN600P	VCC-XZ600P / VCC-XZN600P
Scanning system	PAL standard 625 lines, 50 fields/sec.	
Image sensor	1/4" (approx. 3.6 mm x 2.7 mm) interline transfer method CCD	
Picture elements	Total: 795(H) x 596(V), Effective: 752(H) x 582(V)	
Horizontal resolution	540 TV lines (Typical)	
Minimum illumination (approx.)	50IRE 0.8 lx (at F1.4, GAIN: HIGH, color mode), 0.04 lx (at F1.4, GAIN: HIGH, B/W mode)	20IRE 0.32 lx (at F1.4, GAIN: HIGH, color mode), 0.016 lx (at F1.4, GAIN: HIGH, B/W mode)
Electronic sensitivity boost	AUTO (interlocked with auto iris), up to 32x / OFF	
Video output level	1.0 V (p-p) (75 Ω, composite)	
Video S/N ratio	More than 50 dB (AGC OFF)	
Backlight compensation	ON / OFF, ON = Multi-spot metering / Centre-zone metering / Multi-spot masking Auto / Color / BW settings (3-level adjustment)	
Day/Night	Color / BW switching function (color mode) and burst off/on setting function (B/W mode) can be used via alarm input	
White balance	ATW / AWC / Manual / Outdoor / Indoor / Fluorescent / R/B adjustment possible when using MWB	
Gain control	ON (Low / Normal / Middle / High) / OFF (Gain adjustment possible)	
Motion detector	ON (individual setting possible) / OFF, Motion zoom function (individual setting possible)	
Privacy masking	ON / OFF, max. of 4 masked locations (Wide view screen)	
Electronic shutter	High-speed mode: 1/50, 1/120, 1/250, 1/500, 1/1000, 1/2000, 1/4000, 1/10000 sec. Low-speed mode: 1/25, 1/12, 1/6, 1/3, 1/1.5	
Lens	f = 3.5 to 105mm F1.4 to 3.7 auto focus	
Synchronizing system	Internal sync. / Line lock	
Aperture Horizontal	56 to 2.0°	
Vertical	43 to 1.5°	
Diagonal	68 to 2.5°	
V phase adjustment	LINE PHASE	
Optical zoom	30x	
Electronic zoom	16x	
Communication method	System connection terminals (RS485/Coaxial)*, UTP (NVT built-in)*, support of camera control unit (VAC-70)	
Alarm input	External inputs: 2, NO / NC switch, Day/night switch	
Alarm output	External outputs: 1, NO / NC switch, open corrector	
Mirroring function	OFF / HV / H / V	
Environmental conditions	Temperature: -10°C to 50°C [+14°F to 122°F], Humidity: within 35 to 90% RH	Temperature: -20°C to 50°C [-4° to 122°F], (with power source connected) Humidity: within 90% RH
Power requirement	24V AC ± 10%, 50 Hz or 12 V to 15 V DC	
Power consumption (approx.)	4.9 W (ZM600P) / 7.3 W (ZMN600P)	4.9 W (XZ600P) / 7.3 W (XZN600P)
Dimensions (approx.)	56(W) x 64(H) x 150(D) mm 2.2(W) x 2.5(H) x 5.9(D) in.	141(W) x 172(H) x 400(D) mm 5.6(W) x 6.8(H) x 15.7(D) in.
Weight (approx.)	540 g (19.0 oz.) (ZM600P) 600 g (21.2 oz.) (ZMN600P)	1.77 kg (62.4 oz.) (XZ600P) 1.82 kg (64.2 oz.) (XZN600P)

*VCC-ZM600P and VCC-XZ600P only

Network Specifications

Model No.	VCC-ZMN600P / VCC-XZN600P
Image compression	H.264 / JPEG
Resolution	H.264 720 x 576, 352 x 288, 176 x 144 JPEG 720 x 576, 720 x 288, 640 x 480, 360 x 288, 176 x 144
Picture quality	5 levels
Frame rate	H.264 Max. 25 IPS (720 x 576) JPEG Max. 25 IPS (720 x 576)
Bandwidth	128, 256, 512 Kbps, 1,2,3,4 Mbps, no limitation
Alarm buffer	Up to 8 MB; configurable
Interface	10BASE-T/100BASE-TX (RJ45 connector)
Protocols	TCP, UDP, HTTP, HTTPS, SMTP, NTP, DHCP, FTP, UPnP, DDNS
Simultaneous access capacity	Image: Maximum 16, Voice: Maximum 16 (admin: 1)
Security	BASIC authentication (ID/password), SSL supported (image only)
System requirements	PC IE: CPU: Pentium® 4, 2.0 GHz or higher, Memory: 512 MB, SW3050: CPU 3.0 GHz, Memory: 1 GB or more, Recommended graphics chip: GEFORCE6000 series or higher, OS: Windows® XP
Accessories	CD-ROM (VA-SW3050LITE, Active X, Manual)

Dimensions

Unit: mm (inch)

VCC-ZM600P/ZMN600P

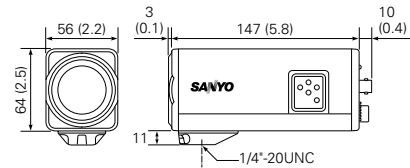

Rear panel

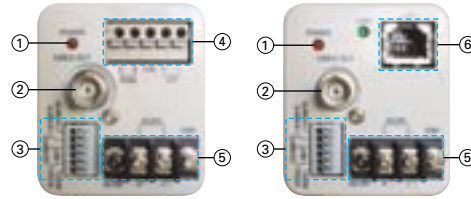

VCC-ZM600P

VCC-ZMN600P

- ① Power indicator (POWER)
- ② Video output connector (BNC connector: VIDEO OUT)
- ③ Control terminals
- ④ System connection terminals (RS485/UTP)
- ⑤ Power connection terminals (AC 24V, DC 12V, GND)
- ⑥ LAN

VCC-XZ600P/XZN600P

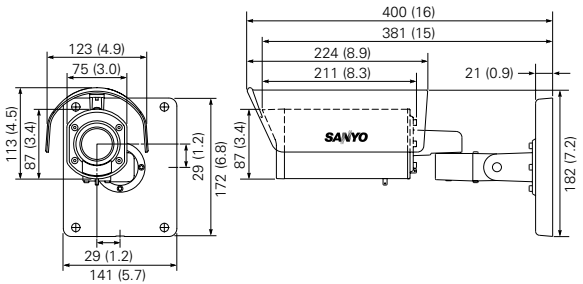

Optinal Accessories (sold separately)



Network Recorder

VA-SW3050S
for server PC

VA-SW3050C
for client PCs



Camera control unit
VAC-70

Microsoft and Windows are either registered trademarks or trademarks of Microsoft Corporation in the United States and/or other countries. Intel and Pentium are trademarks or registered trademarks of Intel Corporation or its subsidiaries in the U.S. and other countries. All other trademarks are the property of their respective owners.

Note:

- Frame rates are variable dependant upon network line conditions and PC performance.
- Because products and software described in this brochure are subject to continuous improvement; SANYO reserves the right to modify product specifications, functions and design without notice.
- Comparative images are representations only.

Caution: Please consult the instruction manual to ensure safe and proper operation of the product.



DI Company of SANYO Electric Co., Ltd.
obtained Quality Management System
ISO 9001 and Environmental Management
System ISO 14001 certifications.

Distributed by:

SANYO

SANYO Electric Co., Ltd.
DI Company
<http://www.sanyosecurity.com>

©2007 SANYO Printed in Japan 2007.11 MA
SMS151